

ZOOM GFX-707

GUITAR EFFECTS PROCESSOR

Operation Manual

CONTENTS

USAGE AND SAFETY PRECAUTIONS	2
Introduction	3
Naming of Parts	4
Front Panel	4
Rear Panel	4
Preparations	4
Inserting the Batteries	4
Getting Connected	5
Quick Guide (Let's Play)	6
Amp Simulator Settings	8
Setting Up the Playback Equipment	8
Selecting the Amp Simulator Type	8
Listening to Patches (Play Mode Operation)	9
Panel Display in Play Mode	9
Selecting a Patch	9
Using the Bypass (Mute) and Tuner Function	10
Playing With Rhythm Accompaniment	11
Using the Sampler Function	12
Using the Easy Edit Function	13
Reserving the Next Patch (DIRECT LOAD)	14
Fixing the Bank (BANK HOLD)	14
Altering the Sound of a Patch (Edit Mode Operation)	15
Patch Configuration	15
Basic Edit Mode Steps	15
Storing and Copying Patches	16
Effect Types and Parameters	17
COMP•DIST (compressor/distortion) module	17
ZNR/EQ (Zoom Noise Reduction/Equalizer) module	17
MOD (modulation) module	18
REV (Reverb) module	19
TOTAL module	20
PEDAL module	20
Using the Jam Play Function	21
Controlling an Effect With the Pedal	22
All Initialize/Factory Recall	23
Adjusting the Expression Pedal	23
Troubleshooting	
GFX-707 Specifications	

USAGE AND SAFETY PRECAUTIONS

USAGE AND SAFETY PRECAUTIONS

In this manual, symbols are used to highlight warnings and cautions for you to read so that accidents can be prevented. The meanings of these symbols are as follows:



Warning

This symbol indicates explanations about extremely dangerous matters. If users ignore this symbol and handle the device the wrong way, serious injury or death could result.



Caution

This symbol indicates explanations about dangerous matters. If users ignore this symbol and handle the device the wrong way, bodily injury and damage to the equipment could result.

Please observe the following safety tips and precautions to ensure hazard-free use of the GFX-707.

• Power requirements



Warning

Since power consumption of this unit is fairly high, we recommend the use of an AC adapter whenever possible. When powering the unit from a battery, use only an alkaline type.

[AC adapter operation]

- Be sure to use only an AC adapter which supplies 9 V DC, 300 mA and is equipped with a "center minus" plug (Zoom AD-0006). The use of an adapter other than the specified type may damage the unit and pose a safety hazard.
- Connect the AC adapter only to an AC outlet that supplies the rated voltage required by the adapter.
- When disconnecting the AC adapter from the AC outlet, always grasp the adapter itself and do not pull at the cable.
- When not using the unit for an extended period, disconnect the AC adapter from the AC outlet.

[Battery operation]

- Use four conventional IEC R6 (size AA) batteries (alkaline).
- The GFX-707 cannot be used for recharging. Pay close attention to the labelling of the battery to make sure you choose the correct type.
- When not using the unit for an extended period, remove the batteries from the unit.
- If battery leakage has occurred, wipe the battery compartment and the battery terminals carefully to remove all remnants of battery fluid.
- While using the unit, the battery compartment cover should be closed.

• Environment



Caution

Avoid using your GFX-707 in environments where it will be exposed to:

- Extreme temperature
- High humidity or moisture

- Excessive dust or sand
- Excessive vibration or shock

• Handling



Caution

Since the GFX-707 is a precision electronic device, avoid applying excessive force to the switches and buttons. Also take care not to drop the unit, and do not subject it to shock or excessive pressure.

• Alterations



Caution

Never open the case of the GFX-707 or attempt to modify the product in any way since this can result in damage to the unit.

• Connecting cables and input and output jacks



Caution

You should always turn off the power to the GFX-707 and all other equipment before connecting or disconnecting any cables. Also make sure to disconnect all cables and the AC adapter before moving the GFX-707.

Usage Precautions

• Electrical interference

For safety considerations, the GFX-707 has been designed to provide maximum protection against the emission of electromagnetic radiation from inside the device, and protection from external interference. However, equipment that is very susceptible to interference or that emits powerful electromagnetic waves should not be placed near the GFX-707, as the possibility of interference cannot be ruled out entirely.

With any type of digital control device, the GFX-707 included, electromagnetic interference can cause malfunctioning and can corrupt or destroy data. Care should be taken to minimize the risk of damage.

• Cleaning

Use a soft, dry cloth to clean the GFX-707. If necessary, slightly moisten the cloth. Do not use abrasive cleanser, wax, or solvents (such as paint thinner or cleaning alcohol), since these may dull the finish or damage the surface.

Please keep this manual in a convenient place for future reference.

Introduction

Thank you for selecting the **ZOOM GFX-707** (hereafter simply called the "**GFX-707**"). The GFX-707 is a sophisticated multi-effect device with the following features and functions:

- **Large variety of built-in effects**

Four separate effect modules (single/combined effects) can be used at the same time, together with ZNR (Zoom Noise Reduction) and the built-in amp simulator. Effects include analog distortion, various modulation effects such as chorus and flanger, and reverberation effects such as reverb and delay. In total, you have a choice of 48 types of effects.

- **60 immediately usable patches**

A combination of effect modules and parameter settings stored in memory is called a "patch". The GFX-707 has room for 30 patches that are read-only and 30 that can be freely modified by the user. So you have a total of 60 patches readily available. Patches are organized in banks (A - F, 0 - 5), each with five patches. It is even possible to assign a distinctive name of up to 6 characters to each patch.

- **Designed for use on stage**

The GFX-707 will operate continuously for up to 14 hours on one set of alkaline batteries. The large display showing patch names is easy to read at a distance, and the built-in expression pedal is great for enhancing any performance. For extended use, the unit can also be powered by an AC adapter.

- **Rotary knobs allow speedy parameter editing**

When editing a patch, the three knobs on the top panel let you change parameters with a quick and direct feel. Even during a performance, fine-tuning an effect is no problem at all. The edited patch can be stored for later use.

- **A first in this class: built-in rhythm section**

A high quality PCM sound source creates realistic rhythm patterns that are handy for practicing or for small jam sessions. You can choose from as many as 45 rhythm patterns.

- **6-second sampler**

Another advantage is the integrated sampler with a recording duration of up to six seconds. It even allows half-speed playback without altering the pitch. This feature comes in handy when copying phrases.

- **Jam Play**

With a simple foot switch operation, you can record and play a phrase of up to 2 seconds during a gig. This is great for creating scratch effects such as used by DJs, doing reverse playback or producing other special effects.

- **Integrated amp simulator**

Simulates the cabinet sound of a guitar amplifier for a dynamic sound also when sending the line output to a mixer or recorder.

Please take the time to read this manual carefully, in order to get the most out of your GFX-707 and to ensure optimum performance and reliability.

Naming of Parts

Front Panel

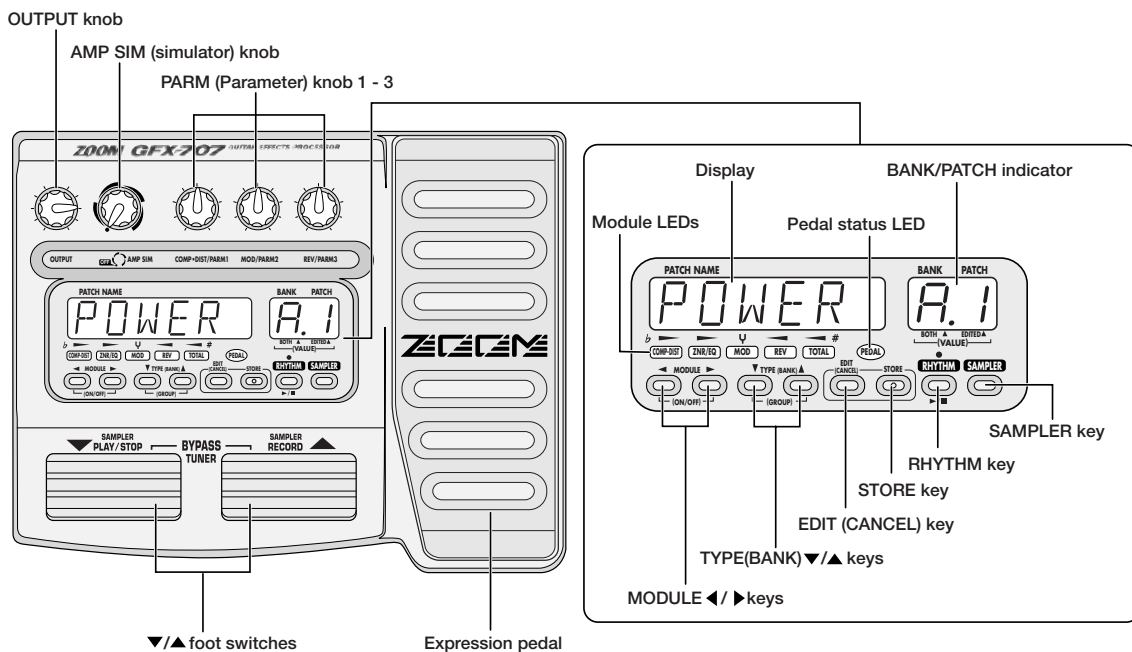

Rear Panel

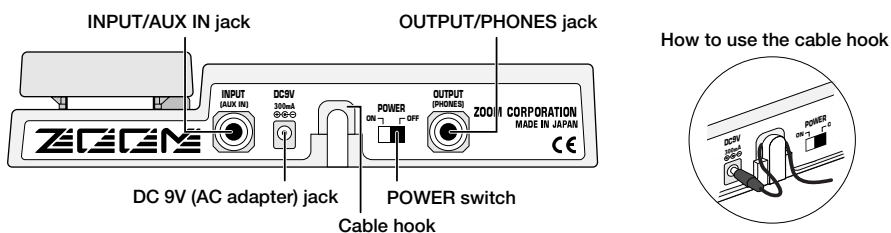

Preparations

Inserting the Batteries

The GFX-707 can be powered either by alkaline batteries or by an AC adapter. To use the unit on batteries, insert them as follows.

- 1 Turn the unit over and open the battery compartment cover.
- 2 Insert four new IEC R6 (size AA) alkaline batteries into the battery compartment.

- 3 Close the battery compartment cover.

If the indication "BATT" appears on the display during battery-powered operation, the batteries are exhausted. Replace all four batteries with fresh ones.

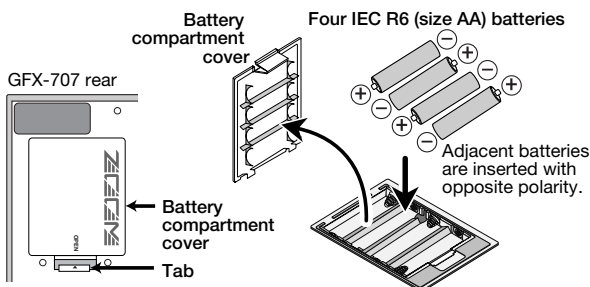

- If the unit is not to be powered from batteries for an extended period, remove the batteries from the battery compartment. Otherwise battery fluid may leak and cause damage to the unit.
- An AC adapter is not supplied with the unit.

Getting Connected

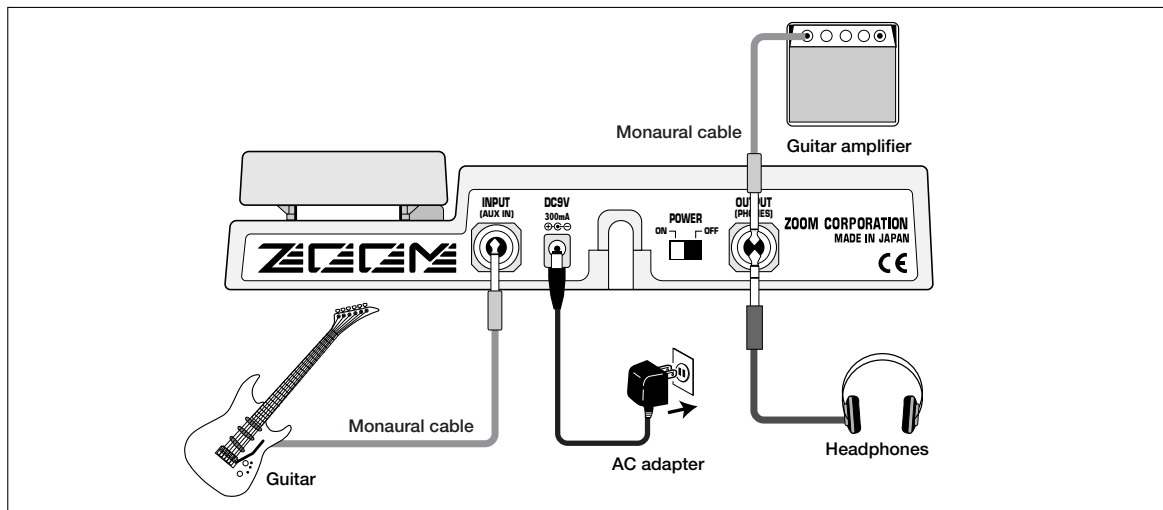

- 1 Use a monaural cable to connect the guitar to the INPUT jack of the GFX-707.

At this time, the amplifier power switch and the power switch of the GFX-707 should be OFF.

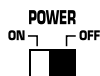

- 2 Use a monaural cable to connect the OUTPUT jack of the GFX-707 to the input of the amplifier.



By using two amplifiers, you can get great stereo sound from stereo effects. Use a stereo Y cable to connect the OUTPUT jack to the two amplifiers.

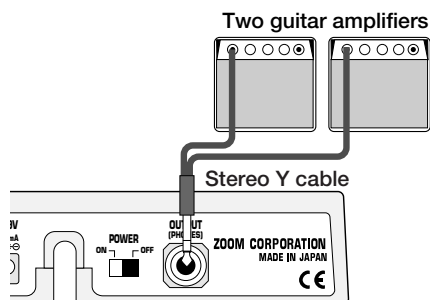

- 3 To monitor the sound with headphones, connect the headphones to the OUTPUT jack.

- 4 Verify that the amplifier is turned off and that the volume control is turned to minimum. Also verify that the power switch of the GFX-707 is set to OFF.

- 5 When using an AC adapter, plug the output cable from the adapter into the DC 9V jack on the GFX-707 and plug the adapter into an AC outlet.



To guard against inadvertently disconnecting the AC adapter cable, wind the cable once around the hook on the rear panel of the GFX-707.

- 6 Turn on power in the order GFX-707 → amplifier (playback equipment).

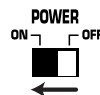

- 7 Adjust the volume of the amplifier and the GFX-707 to a suitable position while playing the instrument.

The OUTPUT knob of the GFX-707 should be set to about the 3 o'clock position, and the AMP SIM knob should be set to the OFF position.

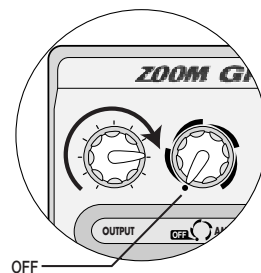

When the GFX-707 is in the bypass state (all effects are temporarily turned off; see page 10), the output level will be the same as the input level if the OUTPUT knob is turned fully clockwise.

Quick Guide (Let's Play)

Immediately after being turned on, the GFX-707 is in the so-called "play mode". The Quick Guide explains the basic steps in play mode. This will let you use the unit right away.

1 Selecting the effect sound (patch)

- 1 To select a patch in play mode, press one of the ▲/▼ foot switches.

The name of the currently selected patch appears on the display. The bank and patch number can be checked using the BANK/PATCH indicator.

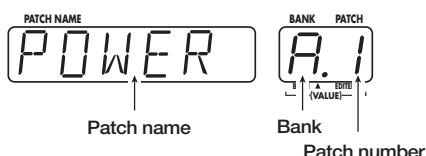

- 2 To directly switch the bank, use the TYPE(BANK) ▼/▲ keys.

- For a detailed explanation of patch switching, p. 9
- To fix the bank, p. 14
- To reserve a patch, p. 14

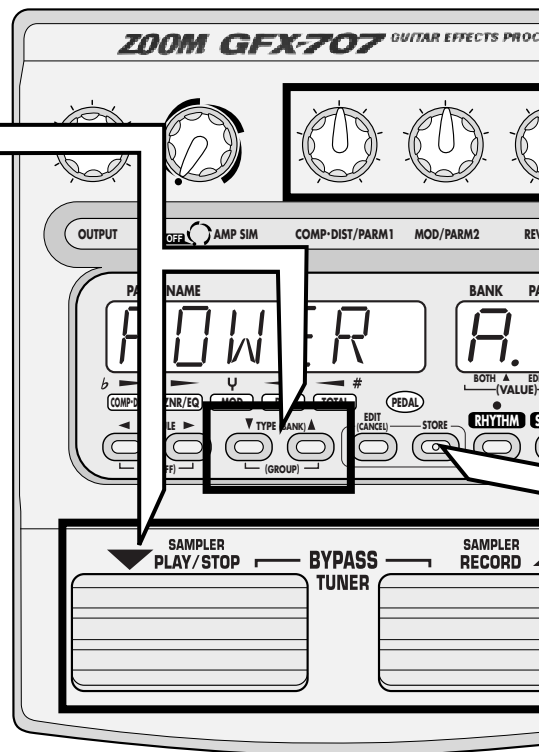

[Patches, groups and banks]

A collection of effect modules, each with distinct parameter settings, is called a patch. The GFX-707 has memory capacity for 60 patches which are immediately available for use. These are divided into two groups of 30 patches each. The PRESET group comprises read-only patches that cannot be changed by the user. The USER group contains read-and-write patches that can be freely overwritten by the user.

Each patch is given a patch name of up to 6 characters, and patches are organized in banks (A - F, 0 - 5) and patch numbers (1 - 5).

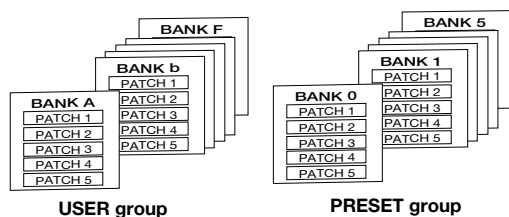

2 Altering an effect with the pedal

- 1 To alter an effect in real time, move the expression pedal while playing your instrument with the GFX-707 in play mode.

The aspect of the patch that is changed by the expression pedal can be programmed for each patch. To get a feel for this, select various patches and try out the pedal to see what it does.

- 2 Push the expression pedal fully down

The expression pedal also incorporates a push-down switch that allows on/off control of a preset effect. The effect that is switched by the push-down switch can be programmed for each patch.

- To set the effect to be altered by the expression pedal, p. 22
- To readjust the expression pedal, p. 23

3 Adjusting an effect (Easy Edit function)

The GFX-707 incorporates a function called "Easy Edit" that allows adjusting effect parameters during play. This is done with three knobs on the front panel. You can vary the patch sound with the ease of a compact effect device.

- 1 In play mode, select the patch whose sound you want to alter, and operate the parameter knob 1 - 3.

The types of parameters assigned to the knobs are as follows.

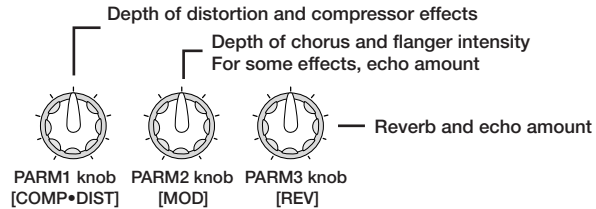

NOTE The actual parameter that is adjusted depends on the patch.

- For a detailed explanation of Easy Edit, p. 13
- For full-fledged editing, p. 15

4 Storing the adjusted effect sound (patch)

- 1 Press the STORE key.

The GFX-707 goes into store standby mode.

STORE? A1

If the store location is not specified, the original bank/patch number is selected. If a patch from the PRESET group was edited, the store location "A1" will be selected. If required, use the TYPE(BANK) ▼/▲ keys and the ▼/▲ foot switches to specify the patch.

- 2 Confirm the store action by pressing the STORE key once more.

The patch is stored and the unit automatically reverts to play mode. To cancel the store action, press the EDIT (CANCEL) key instead of the STORE key in step ②.

- For a detailed explanation of storing a patch, p. 16

5 Using other handy functions

- Using the Amp Simulator, p. 8
- Practicing while listening to a CD or other source, p. 12
- Using the auto tuner, p. 10
- Using hold delay, reverse playback, and scratch playback, p. 21
- Practicing with the built-in rhythm pattern, p. 11

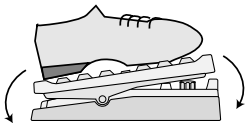
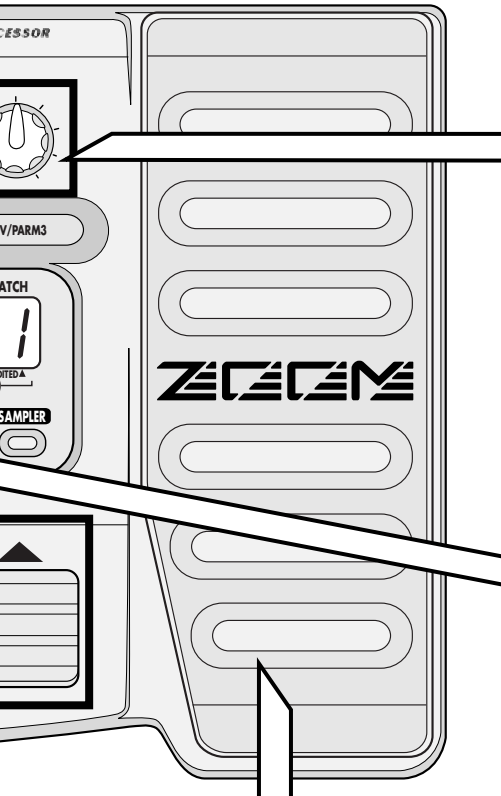

Move back and forth

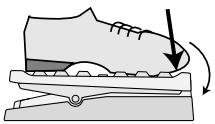

Push down all the way

Amp Simulator Settings

The GFX-707 incorporates an amp simulator that recreates the sound of a guitar amplifier or speaker enclosure. This section explains how to set up the amp simulator.

Setting Up the Playback Equipment

To get the best out of the amp simulator, the playback equipment must be set up correctly. Proceed as described below. After power-up, the GFX-707 is always set up for use with a guitar amplifier. When a guitar amplifier is used exclusively, the following steps are not necessary.

1 In play mode, press the EDIT (CANCEL) key.

2 Press the MODULE ◀/▶ keys repeatedly, until the TOTAL module LED is lit.



3 Press the TYPE (BANK) ▼/▲ keys repeatedly, until the indication "DIRLOD" appears on the display.



4 Turn parameter knob 3.

As soon as you turn parameter knob 3, the display indication changes to "AMPMOD" (amp simulator mode). This is the parameter for selecting the type of amp simulator.



5 Continue to use parameter knob 3 to select one of the following settings. Choose the setting that best matches your setup.

- GFX-707 is connected to a guitar amplifier
AP
- GFX-707 is connected to line level equipment such as a mixer, or used with headphones
Ln

When "AP" is selected, the amp simulator can be used to simulate cabinet sound also when using the guitar amplifier at low levels. When "Ln" is selected, characteristics are optimized for recording.



6 Press the EDIT (CANCEL) key once more.

The unit returns to the play mode. The AMPMOD parameter setting applies to all patches.

NOTE The AMPMOD parameter is reset to "AP" when the GFX-707 is turned off.

Selecting the Amp Simulator Type

Use the AMP SIM knob to select one of the following amp simulator types. When the knob is operated, the name of the currently selected type is shown on the display, and the indication A or b appears on the BANK/PATCH indicator.

- **OFF**
Amp simulator is turned off.
- **COMBO A, b**
This is a combo type amplifier simulation. The "b" position will result in a stronger cabinet sound.
- **BRIGHT A, b**
This is a combo type amplifier simulation with a bright sound character. The "b" position will result in a stronger cabinet sound.

- **STACK A, b**
This is a stack type amplifier simulation. The "b" position will result in a stronger cabinet sound.
- **FL STK A, b**
This is a triple-decker stack type amplifier simulation. The "b" position will result in a stronger cabinet sound.

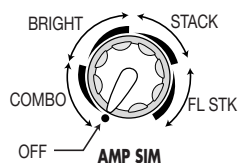

Listening to Patches (Play Mode Operation)

The condition where you call up patches stored in the memory of the GFX-707 and use them for playing your instrument is called "play mode". This is the condition the unit is in when you turn the power on. The various operations possible in play mode are described in this section.

Panel Display in Play Mode

In play mode, the panel shows the following information.

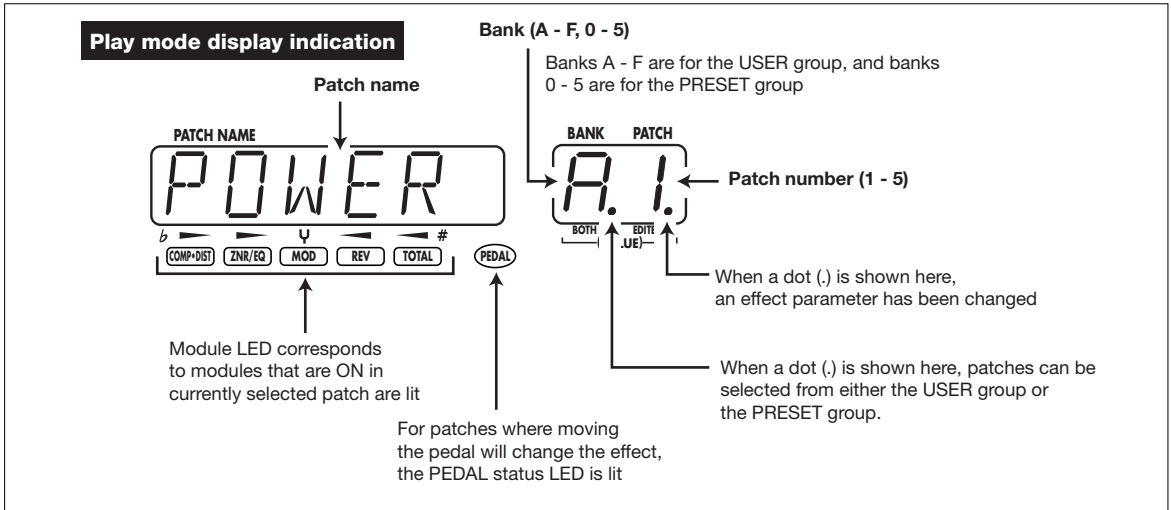

Selecting a Patch

1 To switch patches in play mode, press one of the ▼/▲ foot switches.

Pressing the ▼ foot switch moves to the next lower patch, and pressing the ▲ foot switch moves to the next higher patch. For example, if you press the ▲ foot switch repeatedly, the unit will switch patches, banks, and groups as follows.

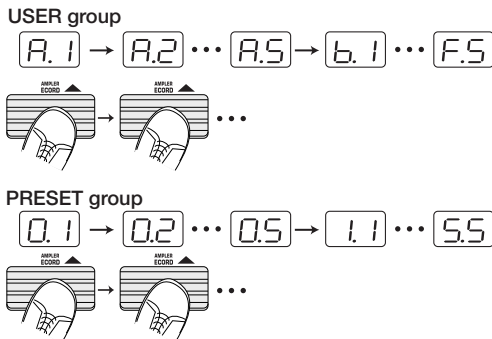

2 To directly switch the bank, use the TYPE (BANK) ▼/▲ keys. This allows you to move to the next lower or next higher bank.

To quickly move to a patch stored at a distant

location, use the TYPE (BANK) ▼/▲ keys together with the ▼/▲ foot switches.

NOTE This is not possible while playing a rhythm pattern.

It is also possible to set up the unit so that only patches from the USER group or from the PRESET group are switched. To do this, press both TYPE (BANK) ▼/▲ keys together. With each push, the group from which patches can be selected is toggled as follows.

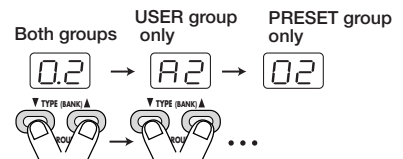

- If you plan to use several patches in a song, copying them to continuous numbers in the USER group will make them easy to call up. For information on copying patches, see p. 14.
- You can also set up the unit to reserve a patch and switch to it only after you confirm the selection. (For details, see p. 14.)

Using the Bypass (Mute) and Tuner Function

The GFX-707 incorporates an auto-chromatic tuner for guitars. To use the tuner function, the built-in effects must be bypassed (temporarily turned off) or muted (original sound and effect sound turned off).

- To set the GFX-707 to the bypass (mute) mode, press and immediately release both ▼/▲ foot switches in play mode.**

The indication "BYPASS" will appear on the display and the BANK/PATCH indicator shows "--".

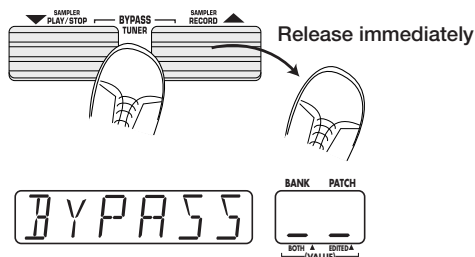

While the GFX-707 is in the bypass condition, the amp simulator is also off and the expression pedal works as a volume pedal.

By pressing both ▼/▲ foot switches for at least 1 second and then releasing them, the GFX-707 is set to the mute condition. The indication "MUTE" will appear on the display and the BANK/PATCH indicator shows "--".

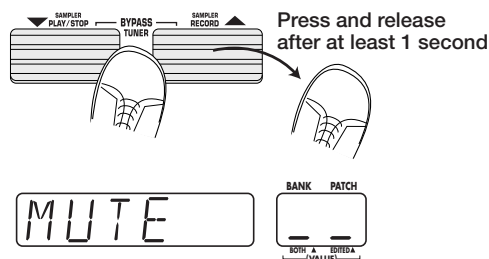

The indication "--" on the BANK/PATCH indicator shows that the tuner is in the input standby condition.

- Play the open string you want to tune, and watch the BANK/PATCH indicator.**

The indicator shows the note which is closest to the current pitch.

A = A	C = C	D = d	E = E	G = G
A# = A#	C# = C#	D# = d#	F = F	G# = G#
B = b		F# = F#		

- When the display shows the desired note, perform fine tuning until the center module LED lights up.**

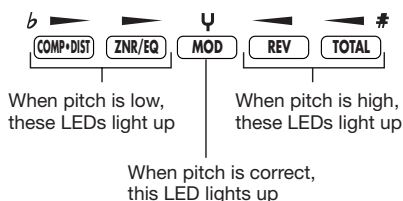

- To change the reference pitch of the tuner, press the TYPE (BANK) ▼/▲ keys.**

The current reference pitch is briefly shown on the display. The default setting after power-on is "440HZ" (center A = 440 Hz).

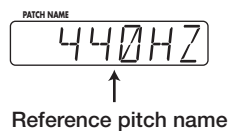

- While the reference pitch is shown, you can change the pitch by pressing the TYPE (BANK) ▼/▲ keys.**

The available setting range is "435HZ" - "445HZ" in 1-Hz steps. When the GFX-707 is turned off and on again, it will be reset to "440HZ".

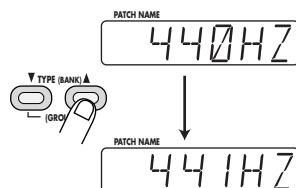

- Pressing one of the ▼/▲ foot switches returns to the play mode.**

Playing With Rhythm Accompaniment

The GFX-707 incorporates various realistic rhythms using a PCM sound source. There are 45 different rhythm patterns from which you can choose. This is great not only for parts practice but also for simple play sessions.

1 To activate a rhythm pattern, press the RHYTHM key in play mode, bypass/mute mode, or edit mode.

Rhythm playback starts. In play mode, the name of the currently selected rhythm pattern appears on the display, and the BANK/PATCH indicator shows the pattern number. During rhythm pattern playback, the rhythm LED flashes in the tempo of the rhythm.



2 To stop rhythm pattern playback, press the RHYTHM key once more.



3 To change the rhythm pattern type, tempo, or volume, operate parameter knobs 1 - 3 in play mode.

The knobs operate as follows.

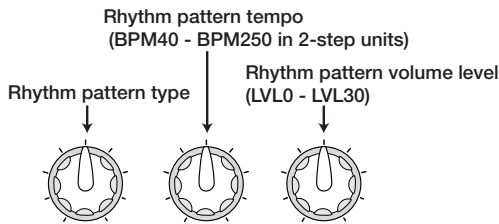

PARM1 knob PARM2 knob PARM3 knob

* BPM = number of quarter note beats per minute, a unit for tempo

When a parameter knob is operated during rhythm pattern play, the content of the BANK/PATCH indicator changes temporarily.

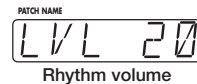

- The settings for rhythm pattern, tempo, and volume level are reset to the default values when the unit is turned off and on again.
- The tempo value can also be changed with the MODULE ◀/▶ keys. In this case, the value changes in 1-step units.
- The TYPE (BANK) ▼/▲ keys can be used to change the pattern type.

[Rhythm pattern list]

Rhythm pattern	Display	BANK/PATCH indicator	
8Beat1	8BEAT	1	Basic patterns
8Beat2	8BEAT	2	
8Beat3	8BEAT	3	
8BeatShuffle	8SHUFL		
16Beat1	16BEAT	1	
16Beat2	16BEAT	2	
16Beat3	16BEAT	3	
16BeatShuffle	16SHFL		
3/4	3/4		Rock patterns
6/8Rock	6/8		
5/4	5/4	1	
5/4Rock	5/4	2	
Rock'nRoll1	R'nR	1	
Rock'nRoll2	R'nR	2	
Rock1	ROCK	1	
Rock2	ROCK	2	
HardRock1	HARD	1	
HardRock2	HARD	2	
Metal1	METAL	1	Dance patterns
Metal2	METAL	2	
Thrash	THRASH		
Punk	PUNK		
Pop1	POP	1	
Pop2	POP	2	
Dance1	DANCE	1	
Dance2	DANCE	2	
Dance3	DANCE	3	
Funk1	FUNK	1	
Funk2	FUNK	2	
Ballad1	BALLAD	1	Other genres
Ballad2	BALLAD	2	
Blues1	BLUES	1	
Blues2	BLUES	2	
Country	COUNTRY		
BossaNova	BOSSA		
Jazz1	JAZZ	1	
Jazz2	JAZZ	2	
Reggae	REGGAE		
Ska	SKA		
Latin1	LATIN	1	
Latin2	LATIN	2	
Metronome (triple)	METRO	3	
Metronome (quadruple)	METRO	4	
Metronome (quintuple)	METRO	5	
Metronome (no beat)	METRO		

Using the Sampler Function

The GFX-707 also incorporates a sampler that allows recording for up to 6 seconds. This can be used not only to record guitar sounds but also for external sources such as a CD player. The data are stored in the memory of the unit and can be played easily using the foot switches. A recorded phrase can also be played at half the original speed without changing the pitch. This is convenient for example to study how a fast guitar phrase played by a pro.

- 1 Connect the recording source to the INPUT jack of the GFX-707.

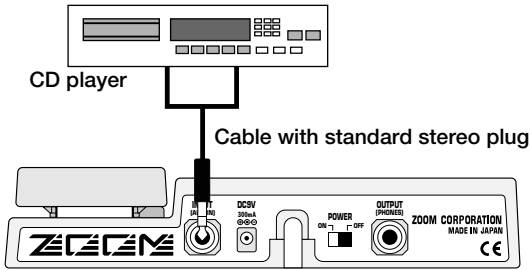

NOTE Before making or changing any connections, be sure to set the OUTPUT knob to the zero position. If a cable is plugged in or unplugged while the OUTPUT knob is turned up, shock noise may damage the speaker.

- 2 To activate the sampler function, press the SAMPLER key in play mode.

The sampler goes into the recording standby mode and the display shows the following information.

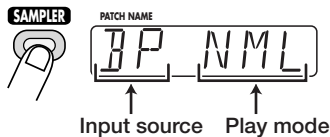

- 3 Turn parameter knob 1 to select "BP" (GFX-707 effects are not used for recording) or "EF" (GFX-707 effects are used for recording).

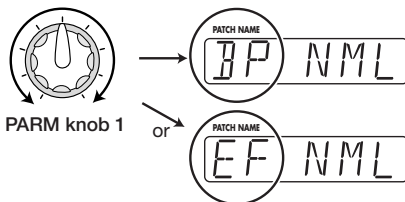

- 4 Turn parameter knob 2 to select "NML" (normal playback speed) or "SLW" (slow playback speed at half tempo without changing pitch).

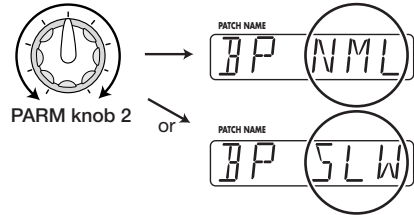

- 5 Push the ▲ foot switch and start playback of the external source (CD player or similar) you want to record, or play the phrase you want to record.

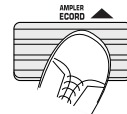

In this mode, the expression pedal operates as controller for the recording level.

During recording, the display shows the indication "RECORDING". The module LEDs on the panel light up in sequence, to show the elapsed time.

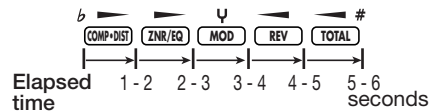

- 6 To terminate the recording, press the ▼ foot switch. Recording stops, and playback immediately starts from the beginning.

During playback, the indication "PLAY" is shown on the display.



If no steps are taken after starting to record,

recording will terminate automatically after 6 seconds, and playback starts.

7 Use the ▼/▲ foot switches and MODULE keys to control playback/stop/rewind/fast-forward.

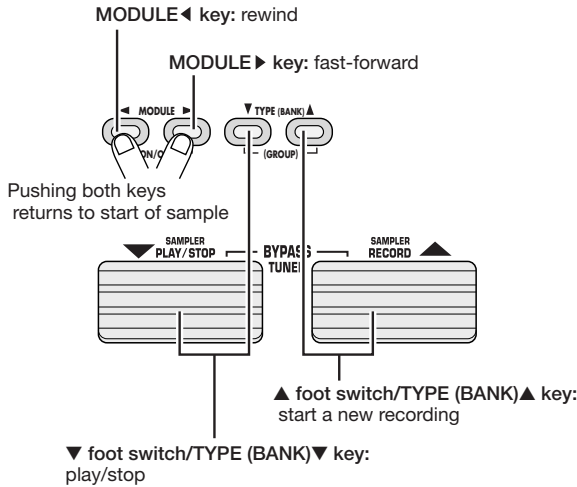

The controls operate as shown at left. When using the controls, you can think of the sampler function as a kind of tape recorder.

8 To turn off the sampler and return to the play mode, press the SAMPLER key again.



- The sampler function cannot be used at the same time as the rhythm function or the Jam Play function.
- While using the sampler function, the MOD module and REV module included in a patch cannot be used. (These modules are set to off, regardless of what the original setting of the patch is.)
- The recorded contents of the sampler are automatically erased when the sampler function is terminated.

Using the Easy Edit Function

Normally, for editing a patch of the GFX-707, you set the unit to edit mode, call up the target parameter, and change the setting. However, it is possible to use the parameter knobs 1 - 3 in play mode to change certain effect parameters. This is called "Easy Edit".

1 To change the sound of a patch in play mode, turn parameter knobs 1 - 3. The parameters controlled by the knobs are as follows.

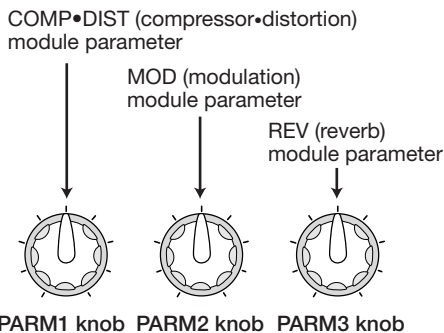

The actual parameter controlled by the parameter knob 1 - 3 depends on the patch.

When a knob is turned, the current setting of the affected parameter is shown on the BANK/PATCH indicator, and a dot (.) appears at the "EDITED" position. This indicates that the parameter has

been changed. If the parameter is returned to the original setting, the dot disappears.

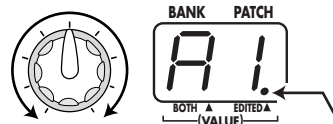

Shows that parameter has been changed



Besides the above parameters, the MODULE ◀/▶ keys can be used to change the PATCH LEVEL parameter.

2 To store an edited patch, carry out the steps for storing (see p. 16).

If another patch is called up without storing the edited patch, the edited contents will be lost.



The Easy Edit function is not available while using the rhythm pattern.

Reserving the Next Patch (DIRECT LOAD)

In the factory default condition, patches are switched as soon as you make the selection, resulting in an immediate change in the sound. This is called "Direct Load". If you want to change to a distant patch (for example from patch A1 to patch E5), all the intermediate patches will briefly change the sound, which may not be desirable. In such a case, you can reserve the patch and cause the patch change to be delayed until confirmed by you. This function is activated as follows;

- 1 In play mode, press the **EDIT (CANCEL)** key.
- 2 Use the **MODULE** ◀/▶ keys to cause the **TOTAL** module LED to light up.



- 3 Use the **TYPE (BANK)** ▼/▲ keys to cause the indication "DIRLOD" (Direct Load) to appear on the display.

This parameter determines whether the sound is switched immediately when a patch is selected.



- 4 Turn parameter knob 1 so that the **BANK/PATCH** indicator shows "oF".



- 5 Press the **EDIT (CANCEL)** key once more.

The unit returns to the play mode, and reserving a patch is now possible. When a new patch is selected in this condition, the **BANK/PATCH** indicator and the patch name on the display are flashing, but the sound does not change yet. This shows that the unit is waiting for confirmation from the user.

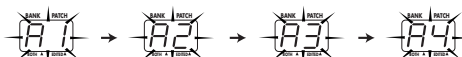

To confirm the patch change, press both ▼/▲ foot switches at the same time. The **BANK/PATCH** indicator and display indication stop flashing, and the sound of the new patch becomes active.

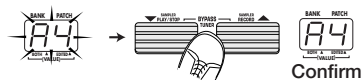

- To return to the original operation mode, set the **DIRLOD** parameter to "on".
- The **DIRECT LOAD** setting is stored automatically by the unit. There is no need to perform any steps for storing.

Fixing the Bank (BANK HOLD)

In play mode, you can fix the bank so that only patches within that bank are switched.

- 1 In play mode, press the **EDIT (CANCEL)** key.
- 2 Use the **MODULE** ◀/▶ keys to cause the **TOTAL** module LED to light up.
- 3 Use the **TYPE (BANK)** ▼/▲ keys to cause the indication "DIRLOD" (Direct Load) to appear on the display.



- 4 Turn parameter knob 2.

As soon as you operate parameter knob 2, the display indication changes to "BNKHLD" (Bank Hold). This parameter determines whether the bank is fixed in play mode or not. The default setting is "oF".



- 5 Keep on turning parameter knob 2 until the **BANK/PATCH** indicator shows "on".
- 6 Press the **EDIT (CANCEL)** key once more.

The unit returns to the play mode. The **BNKHLD** parameter setting is reset to "off" when the **GFX-707** is turned off and on again.

When Bank Hold is activated, repeatedly pressing ▲ foot switch will switch patches only within the current bank, as shown below.

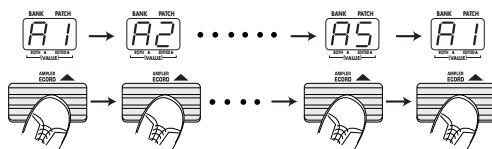

- In the **Bank Hold** condition, the bank can still be switched with the **TYPE (BANK)** ▼/▲ keys.
- To return to the original setting, set the **BNKHLD** parameter to "oF".

Altering the Sound of a Patch (Edit Mode Operation)

The edit mode allows you to freely alter the parameters that make up a patch, so that you can create your own patches. This section describes the operation steps.

Patch Configuration

Each patch of the GFX-707 consists of several effects (effect modules), as shown in the illustration below. A patch is a combination of modules, each with their distinct parameter settings.

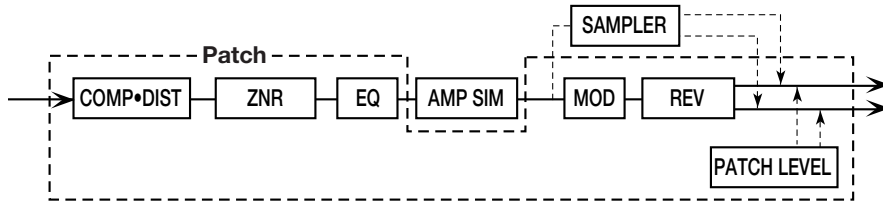

Within each module, there are several effects which are called effect types. For example, the REV (reverb) module comprises effect types such as HALL, ROOM, and PP-DLY (ping-pong delay).

The elements that determine the sound of a patch are called effect parameters. Each module has several effect parameters, whose value can be adjusted with the parameter knobs 1 - 3.

HINT Also within the same module, different effect types will have different parameters.

Basic Edit Mode Steps

1 In play mode, select the patch you want to edit.

Patches for editing can be selected from either the USER group or the PRESET group. However, the PRESET group does not allow storing. When you have altered a patch from the PRESET group and want to store it, you must select a location in the USER group.

2 Press the EDIT (CANCEL) key.

The GFX-707 switches to the edit mode. Immediately after the edit mode is activated, the TOTAL module will be selected.

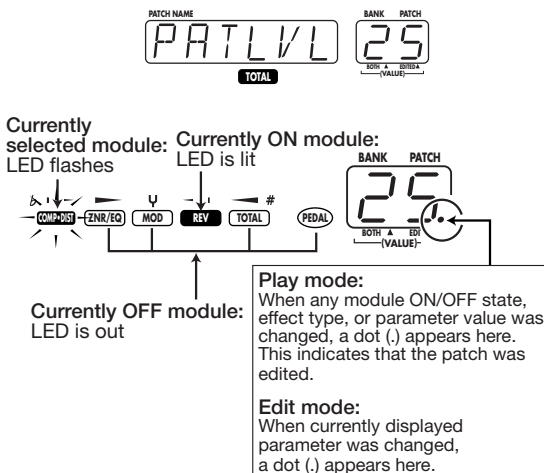

3 Use the MODULE ◀/▶ keys to select the module you want to edit.

Modules are switched in the following order, and the respective module LED is flashing.

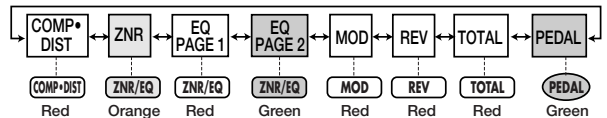

The display shows the effect type currently selected for that module. If the currently selected module is OFF, the indication "-oFF-" is shown on the display.

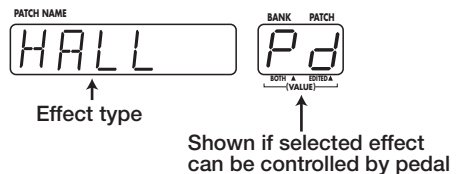

4 To change the effect type, use the TYPE (BANK) ▼/▲ keys.

For details on effect types and parameters for each module, see [page 17 - 20](#).

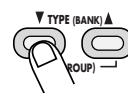

5 Use parameter knobs 1 - 3 to change the parameter setting.

In edit mode, the parameter knobs 1 - 3 serve to adjust the parameters 1 - 3 of the currently selected module.

When one of parameter knobs 1 - 3 is turned, the name of the corresponding parameter appears on the display and the current value on the BANK/PATCH indicator.

For example, if the effect type ROOM of the REV module is selected, the parameter knobs 1 - 3 will adjust the following parameters.

- Parameter knob 1TIME
- Parameter knob 2TONE
- Parameter knob 3MIX

To check the value of a parameter without moving the parameter knob, press the TYPE (BANK) ▼/▲ keys together. With each push of the two keys, the names of parameters 1 - 3 and the respective settings are shown.

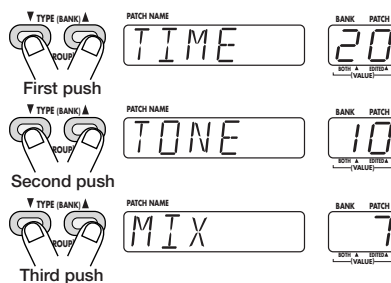

6 To switch the ON/OFF status of a module, press the MODULE ◀/▶ keys together.

7 Repeat steps 3 - 6 to edit other modules

8 When editing is completed, press the EDIT (CANCEL) key.

The GFX-707 returns to the play mode. A dot (.) appears at the "EDITED" position of the BANK/PATCH indicator, to indicate that the patch has been edited.

Storing and Copying Patches

Unless you store an edited patch in the memory of the unit, the edited contents will be lost (the patch will revert to its original condition) when you select another patch. If you have created a patch you like, do not forget to store it. It is also possible to store an existing patch in another location, thereby creating a copy. By copying several patches you want to use in a song to adjacent numbers in the USER group, you can easily call them up during a performance.

1 In play mode or edit mode, press the STORE key.

The GFX-707 enters the store standby condition. If the STORE key is pressed while using the rhythm function, the rhythm output is stopped and the unit then enters the standby condition. When storing an edited patch, be sure to change the patch name. This is done with the TOTAL module (👉 p. 20).

2 Use the TYPE (BANK) ▼/▲ keys and ▼/▲ foot switches to select the store target (copy target).

If you do not specify the store target, the original bank/patch number becomes the store target. When you change the store target bank/patch number, the changed portion on the BANK/PATCH indicator flashes. The indication "STORE?" and the store target patch name are

flashing alternately on the display.



3 To execute the patch store (copy) process, press the STORE key once more.



Storing is carried out, and the unit returns to the play mode. To abort the store process, press the EDIT (CANCEL) key before step 3.





- The PRESET group is read-only. If a patch from the PRESET group was selected and the STORE key is pressed, the store target automatically becomes "A1". Change the bank/patch number as required.
- When store (copy) is carried out, the previous patch in the target is overwritten (erased). If that patch was edited, its contents cannot be restored. However, it is possible to restore a selected patch or all patches from the USER group (👉 p. 23) to the factory defaults.

Effect Types and Parameters

In this section, all effect types and parameters of the GFX-707 are explained. Parameters that are the same for several effects are explained in detail only the first time they appear.

The [] mark indicates that this parameter can be assigned to the expression pedal ( p. 22).



The  -  marks indicate parameters that can be controlled with the parameter knobs 1 - 3 in play mode.

COMP•DIST (compressor/distortion) module

In addition to various distortion effects such as overdrive and fuzz, this module contains a clean compressor and acoustic guitar simulator.

TYPE 1 ACOSIM (Acoustic simulator)

This effect makes an electric guitar sound like an acoustic guitar.

Parameter 1 **TOP** 1 - 10  

Adjusts characteristic sound of acoustic guitar strings.

Parameter 2 **BODY** 1 - 10

Adjusts body resonance.

Parameter 3 **LEVEL** 1 - 8

Adjusts volume level after passing COMP•DIST module.

TYPE 2 CMP FS (Compressor/fast)

This is a fast-attack compressor.

* TYPE 2 and 3 parameters are identical.



Parameter 1 **COLOR** FL, Ft, bt

Selects sound character.

FL(Flat): Clean sound with flat characteristics

Ft(Fat Clean): Clean sound with prominent midrange

bt(Bright): Clean sound with vivid mid/high range

Parameter 2 **COMP** oF, 1 - 10  

Adjusts depth of compressor effect. "oF" means that effect is disabled.

Parameter 3 **LEVEL** 1 - 8

Adjusts volume level after passing COMP•DIST module.



TYPE 3 CMP SL (Compressor/slow)

This is a slow-attack compressor.

TYPE 4 CMP+CR (Compressor + Crunch)

Combination of compressor and crunch.

* TYPE 4 - 7 parameters are identical.

Parameter 1 **GAIN** 1 - 30  

Adjusts distortion depth.

Parameter 2 **COMP** oF, 1 - 10

Adjusts depth of compressor effect.

Parameter 3 **LEVEL** 1 - 8

Adjusts volume level after passing COMP•DIST module.

TYPE 5 CMP+OD (Compressor + Overdrive)

This is a combination of compressor and overdrive.

TYPE 6 CMP+DS (Compressor + Distortion)

This is a combination of compressor and distortion.

TYPE 7 CMP+FZ (Compressor + Fuzz)

This is a combination of compressor and fuzz.

TYPE 8 OD1 (Overdrive 1)

This effect produces a dry overdrive sound. * TYPE 8 - 16 parameters are identical.

Parameter 1 **GAIN** 1 - 30  

Adjusts distortion intensity.

Parameter 2 **TONE** 0 - 10

Adjusts tonal quality.

Parameter 3 **LEVEL** 1 - 8

Adjusts volume level after passing COMP•DIST module.

TYPE 9 OD2 (Overdrive 2)

This effect produces an overdrive sound with a pronounced cabinet character.

TYPE 10 DIST2 (Distortion 2)

This effect produces a dry distortion sound.

TYPE 11 DIST2 (Distortion 2)

This effect produces a strong distortion sound.

TYPE 12 FUZZ

Produces fuzz sound reminiscent of the sixties.

TYPE 13 WILD FZ (Wild Fuzz)

Produces high-gain, aggressive fuzz sound.

TYPE 14 LEAD

Produces sound with a distinctive midrange character.



TYPE 15 METAL

Produces high-gain sound with boosted low and high end.

TYPE 16 PWR DRV (Power Drive)

Simulates the sound of a large amplifier.

ZNR/EQ (Zoom Noise Reduction/Equalizer) module

This module contains a 4-band equalizer for making tone adjustments. The equalizer has only one effect type, but because there are many parameters, it is divided into two pages titled EQ P1 and EQ P2. (Use the MODULE  /  keys to switch between pages.) This module also comprises the ZNR settings.

ZNR (Zoom Noise Reduction)

The original noise reduction developed by Zoom cuts noise during performance pauses without impairing the sound quality.

Parameter 1 **ZNR** oF, 1 - 7

Adjusts ZNR sensitivity. The recommended approach is to set the value as high as possible without producing an unnatural cut of the instrument sound. When set to "oF", ZNR is disabled.

NOTE  ZNR operates independently of the EQ module. The ZNR setting will be active also if the EQ module is off, and the EQ module and ZNR can also be used together.

EQ P1 (EQ page 1)

This page of the 4-band equalizer allows adjustment from the extreme high range to the midrange.

Parameter 1 **PRESEN** -12 - 12

Controls boost/cut in ultra high range (center frequency 8 kHz).

Parameter 2 **HIGH** -12 - 12

Controls boost/cut in high range (center frequency 3.125 kHz).

Parameter 3 **MIDDLE** -12 - 12

Controls boost/cut in midrange (center frequency 800 Hz).

EQ P2 (EQ page 2)

This page of the 4-band equalizer allows adjustment in the low range.

Parameter 1 **LOW F** 1, 2

1 selects the ultra low range (center frequency 63 Hz) and 2 the low range (center frequency 125 Hz).

Parameter 2 **LOW G** -12 - 12

Controls boost/cut in the range selected with LOW F.

Parameter 3 **LEVEL** 1 - 8

Adjusts volume level after passing EQ module.



MOD (modulation) module

This module comprises spatial effects such as chorus and flanger, filter effects such as auto wah, and modulation effects such as ring modulator.

TYPE 1 CHORUS

This stereo chorus effect produces a clear and very wide sound stage.

Parameter 1 DEPTH 0 – 10

Adjusts effect depth.

Parameter 2 RATE 1 – 30

Adjusts modulation speed.

Parameter 3 MIX 0 – 30

Adjusts effect mix ratio.

TYPE 2 V-CHO (Vintage Chorus)

This chorus effect is characterized by warm and smooth sound.

Parameter 1 DEPTH 0 – 10

Adjusts effect depth.

Parameter 2 RATE 1 – 30

Adjusts modulation speed.

Parameter 3 MIX 0 – 30

Adjusts effect mix ratio.

TYPE 3 FLANGE (Flanger)

This effect produces a unique, undulating sound.

Parameter 1 DEPTH 0 – 10

Adjusts effect depth.

Parameter 2 RATE 1 – 30

Adjusts modulation speed.

Parameter 3 FB -10 – 10

Adjusts feedback level. Increasing this value in the plus or minus direction emphasizes the distinctiveness of sound, but with different tonal character.

TYPE 4 PHASE

This effect results in a swooshing sound.

Parameter 1 POSI AF, bF

Selects connection order of COMP•DIST module and MOD module, as follows.

AF: COMP•DIST →MOD

bF: MOD →COMP•DIST

Parameter 2 RATE 1 – 30

Adjusts modulation speed.

Parameter 3 COLOR 1 – 4

Selects phase sound type.

TYPE 5 TREMOL (Tremolo)

This effect periodically varies the level of the sound.

Parameter 1 TOPDEPTH 0 – 10

Adjusts effect depth.

Parameter 2 RATE 1 – 30

Adjusts modulation speed.

Parameter 3 CLIP 0 – 10

Adjusts modulation waveform clip. Larger values result in more intense modulation.

TYPE 6 A-PAN (Auto Pan)

This stereo panning effect periodically moves the sound back and forth between the right and left channel.

Parameter 1 WIDTH 0 – 10

Adjusts effect width.

Parameter 2 RATE 1 – 30

Adjusts modulation speed.

Parameter 3 CLIP 0 – 10

Adjusts modulation waveform clip.

TYPE 7 A-WAH (Auto Wah)

This effect gives a varying wah sound that depends on the picking intensity.

Parameter 1 POSI AF, bF

Selects connection order of COMP•DIST module MOD module, as follows.

AF: COMP•DIST →MOD

bF: MOD →COMP•DIST

Parameter 2 RESO 1 – 10

Adjusts wah effect intensity.

Parameter 3 SENS -10 – -1, 1 – 10

Adjusts sensitivity. Negative values result in downward wah.

TYPE 8 P-WAH (Pedal Wah)

This effect lets you control wah with the expression pedal.

Parameter 1 POSI AF, bF

Selects connection order of COMP•DIST module and MOD module.

Parameter 2 FREQ 1 – 10

Adjusts wah effect center frequency.

Parameter 3 DIRMIX 0 – 10

Adjusts original sound mix.



For the MODE parameter of the PEDAL module (p. 20), "Hi" and "Lo" is equivalent to "dn".

TYPE 9 STEP

This is a special effect with step-like filter characteristics.

Parameter 1 DEPTH 0 – 10

Adjusts depth.

Parameter 2 RATE 1 – 30

Adjusts modulation speed.

Parameter 3 RESO 0 – 10

Adjusts effect intensity.

TYPE 10 PITCH (Pitch Shifter)

This is a pitch shifter with a range of 1 octave up and 2 octaves down.

Parameter 1 PITCH -12, ...-1, dt, 1, ... 12, 24

Sets the pitch shift amount. The "dt" setting results in a detune effect.

Parameter 2 TONE 0 – 10

Adjusts effect tone.

Parameter 3 BAL 0 – 30

Adjusts balance between effect sound and direct sound. Higher values emphasize effect sound.

TYPE 11 P-PIT (Pedal Pitch)

This effect lets you vary the pitch in real time, using the expression pedal.

Parameter 1 TYPE 1 – 16

Selects the pedal pitch type. Depending on the type, the pitch when pushing the pedal down or when raising it differs.

P-PIT TYPE	Pedal	
	minimum value	maximum value
1	-100 cent	Original sound only
2	Original sound only	-100 cent
3	DOUBLING	Detune + DRY
4	Detune + DRY	DOUBLING
5	0 cent	+1 octave
6	+1 octave	0 cent
7	0 cent	-2 octaves
8	-2 octaves	0 cent
9	-1 octave + DRY	+1 octave + DRY
10	+1 octave + DRY	-1 octave + DRY
11	-700 cent + DRY	500 cent + DRY
12	500 cent + DRY	-700 cent + DRY
13	-∞ (0 Hz) + DRY	+1 octave
14	+1 octave	-∞ (0 Hz) + DRY
15	-∞ (0 Hz) + DRY	+1 octave + DRY
16	+1 octave + DRY	-∞ (0 Hz) + DRY

Parameter 2 TONE 0 – 10

Adjusts effect tone.



Regardless of the MODE parameter setting of the PEDAL module (p. 20), this effect type causes the same operation as "UP".

TYPE 12 RING-M (Ring Modulator)

This effect produces a metallic sound.

Parameter 1 POSI AF, bF

Selects connection order of COMP•DIST module and MOD module.

Parameter 2 RATE 1 - 30

Sets frequency for ring modulation effect. The tone changes considerably depending on the frequency setting.

Parameter 3 BAL 0 - 30

Adjusts balance between effect sound and direct sound.

TYPE 13 SLOW-A (Slow Attack)

This effect automatically creates a "violin playing" sound depending on the picking intensity.

Parameter 1 POSI AF, bF

Selects connection order of COMP•DIST module and MOD module.

Parameter 2 TIME 1 - 30

Adjusts attack speed.

Parameter 3 CURVE 1 - 10

Adjusts attack curve.

TYPE 14 FILTER

This effect tracks the picking action and controls filter opening accordingly.

Parameter 1 POSI AF, bF

Selects connection order of COMP•DIST module and MOD module.

Parameter 2 TIME 1 - 30

Adjusts attack speed.

Parameter 3 MIX 0 - 30

Sets the adjustable filter range.



It is recommended to use the filter effect only with single notes.

TYPE 15 DELAY

This is a ping-pong delay with a delay time of up to 500 ms (milliseconds).

Parameter 1 TIME 1 - 50

Adjusts delay time in 10-ms steps.

Parameter 2 FB 0 - 10

Adjusts feedback amount. Higher values result in more delay repetitions.

Parameter 3 RANGE 1 - 10

TYPE 16 ECHO

This effect produces a soft echo similar to a tape echo.

Parameter 1 TIME 1 - 50

Adjusts delay time in 10-ms steps.

Parameter 2 FB 0 - 10

Adjusts feedback amount.

Parameter 3 MIX 0 - 30

TYPE 17 T-TRIP (Time Trip)

This is a new kind of delay effect which varies the delay time according to the picking intensity.

Parameter 1 SENS 1 - 50

Adjusts effect sensitivity.

Parameter 2 FB -10 - 10

Adjusts feedback amount.

Parameter 3 BAL 0 - 30

Adjusts balance between effect sound and direct sound.

TYPE 18 TRMCHO (Tremolo + Chorus)

This is a combined tremolo and chorus effect.

Parameter 1 TRAMRAT 1 - 30

Adjusts tremolo speed.

Parameter 2 CHORAT 1 - 30

Adjusts modulation speed of chorus effect.

Parameter 3 CHOMIX 0 - 30

Adjust chorus sound mix.

TYPE 19 RINVIB (Ring Modulator + Vibrato)

This is a combined ring modulator and vibrato effect.

Parameter 1 RINRAT 1 - 30

Adjusts ring modulation effect frequency.

Parameter 2 VIBRAT 1 - 30

Adjusts vibrato effect speed.

Parameter 3 VIBDEP 0 - 10

Adjusts vibrato effect depth.

TYPE 20 VIBE

This is a vibrato effect.

Parameter 1 DEPTH 1 - 30

Adjusts effect depth.

Parameter 2 RATE 1 - 30

Adjusts effect speed.

Parameter 3 BAL 0 - 30

Adjusts balance between effect sound and direct sound.



REV (Reverb) module

Besides reverb and delay effects, this module also contains sophisticated jam effects using latest sampling technology.

TYPE 1 HALL

This is a reverb effect which simulates the acoustics of a concert hall.

* TYPE 1 and 2 parameters are identical.

Parameter 1 TIME 1 - 30

Adjusts reverb duration (reverb time).

Parameter 2 TONE 0 - 10

Adjusts effect tone.

Parameter 3 MIX 0 - 30

Adjusts effect mix.

TYPE 2 ROOM

This is a reverb effect which simulates the acoustics of a room.

TYPE 3 PP-DLY (Ping-Pong Delay)

This is a ping-pong delay effect with a duration of up to 1.5 seconds.

Parameter 1 TIME 1 - 99, 1.0 - 1.5

Adjusts delay time from 10 ms to 990 ms in 10-ms steps.

(1 - 99), and over 1 second in 100-ms steps (1.0 - 1.5).

Parameter 2 FB 0 - 10

Adjusts feedback amount.

Parameter 3 MIX 0 - 30

Adjusts effect mix.

TYPE 4 DLYHAL (Delay + Hall)

This is a combined delay and hall effect.

* TYPE 4 and 5 parameters are identical.

Parameter 1 DLYTIM 1 - 50

Adjusts delay time in 10-ms steps.

Parameter 2 DLYMIX 0 - 15

Adjusts delay mix.

Parameter 3 REVMIX 0 - 15

Adjusts reverb mix.

TYPE 5 DLYROM (Delay + Room)

This is a combined delay and reverb effect.

JAM (Jam Play)

This is a special effect that lets you record a guitar phrase during play and reproduce it in various ways.

Parameter 1 **nM, rS, SC** 

Selects playback method for recorded phrase.

nM (Normal): Play in normal direction.

rS (Reverse): Play in reverse direction.

SC (Scratch): Use expression pedal to play with scratch type effect. From center position, pedal controls either forward or reverse playback.

Parameter 2

Selects playback method for ▼ foot switch.

tS (Trigger One-Shot): Pressing ▼ foot switch causes one play run from start. Pressing ▼ foot switch during play stops play.

tL (Trigger Loop): Pressing ▼ foot switch causes loop play.

Pressing ▼ foot switch during play stops play.

GS (Gate One-Shot): While ▼ foot switch is pressed, one play run from start is performed. Releasing ▼ foot switch stops play.

GL (Gate Loop): While ▼ foot switch is pressed, loop play from start is performed. Releasing ▼ foot switch stops play.

rS (Retrigger One-Shot): Pressing ▼ foot switch causes one play run from start. Pressing ▼ foot switch during play causes restart from beginning.

Parameter 3 **0 – 30**

Adjusts effect mix.



For a detailed explanation of Jam Play, see page 21.

TOTAL module

TOTAL is not an independent effect module. Rather it serves to set parameters that affect all patches or the entire GFX-707. You can switch between the TOTAL 1 and TOTAL 2 pages with the TYPE (BANK) ▼/▲ keys.

TOTAL 1

Parameter 1

Parameter 2

Parameter knobs 1 and 2 let you input or edit a patch name. Knob 1 specifies the character input position (indicated by the flashing part of the display), and knob 2 selects the alphanumeric character to be input at that position.

(Space)	/	<	>	*	+	-	/	0	1	2	3	4
(Space)	'	()	*	+	-	/	0	1	2	3	4
5	6	7	8	9	<	=	>	?	@	A	B	C
5	6	7	8	9	<	=	>	?	@	A	B	C
D	E	F	G	H	I	J	K	L	M	N	O	P
D	E	F	G	H	I	J	K	L	M	N	O	P
Q	R	S	T	U	V	W	X	Y	Z	\		
Q	R	S	T	U	V	W	X	Y	Z	\		

Parameter 3 **1 – 30**

Sets final patch level. Level adjustment is performed with parameter knob 3. A value of 25 corresponds to unity gain.

TOTAL 2

Parameter 1 **on, oF**

Switches Direct Load function on and off. When "on", the sound changes immediately when the patch is switched (default). When "oF", reading in the new patch is delayed until confirmed by the user.

This parameter applies to all patches. It is stored automatically when the parameter setting is changed.

Parameter 2 **on, oF**

Switches Bank Hold function on and off. When "oF", repeatedly pressing the ▲ foot switch cycles through all patches and banks, such as A1 → A2 → A3 → A4 → A5 → B1. When "on", the bank is fixed and patches are switched only within the bank, such as A1 → A2 → A3 → A4 → A5 → A1.

This parameter applies to all patches. It is reset to "oF" at power-on.

Parameter 3 **AP, Ln**

Adapts characteristics of built-in amp simulator to usage environment of unit. When GFX-707 is connected to guitar amplifier, use "AP". For connection to line-level equipment such as mixer or recorder, use "Ln".

This parameter applies to all patches. It is reset to "AP" at power-on.

PEDAL module

Strictly speaking, the PEDAL module is not an effect module. It contains various settings for the expression pedal.

Parameter 1 **oF, VL, dS, Md, rV**

Selects module to be assigned to expression pedal.

oF: Off

VL: Volume

dS: COMP•DIST module

Md: MOD module

rV: REV module

Parameter 2 **UP, dn, Hi, Lo**

Determines how parameter changes when pedal is moved.

UP: Parameter minimum value → maximum value (forward direction)

dn: Parameter maximum value → minimum value (reverse direction)

Hi: Current value → maximum value (forward direction)

Lo: Minimum value → current value (forward direction)

Parameter 3 **0 – 10**

Sets minimum value when using expression pedal as volume pedal (ASSIGN parameter set to "VL").



When using the expression pedal as a volume pedal, the volume changes from the MINVOL value to the maximum value in the forward direction, regardless of the MODE parameter setting.



Parameters 1 and 2 can be set for each patch and are stored when the patch is stored. Parameter 3 applies to all patches and is automatically stored when the setting is changed.



For information on adjusting parameters with the expression pedal, see page 22.

Using the Jam Play Function

Besides its regular sampler, the GFX-707 incorporates a Jam Play feature that records and plays a guitar phrase of up to 2 seconds. This allows hold delay, and the phrase can also be played in reverse. The direction and speed of playback can be controlled with the expression pedal, letting you achieve a "scratch" effect such as used by DJs. To use Jam Play, select a patch for which the effect type of the REV module is set to JAM, and set the STYLE parameter (playback method) and TRG/GT parameter (foot switch function) as desired.

- 1 Select the patch to use with Jam Play.**
- 2 Activate edit mode, and select JAM as effect type for the REV module (p. 15). Verify that the REV module is ON.**
- 3 Turn parameter knob 1 and select the STYLE parameter (playback method for recorded phrase).**

nM (Normal): Play in normal direction.

rS (Reverse): Play in reverse direction.

SC (Scratch): Use expression pedal to play with scratch type effect. From center position, pedal controls either forward or reverse playback.

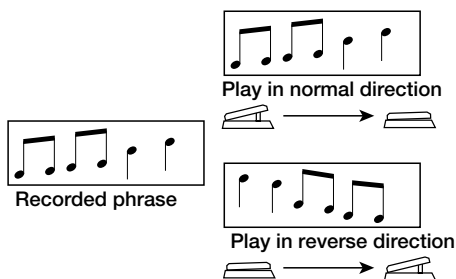

- 4 When the STYLE parameter is set to "nM" (Normal) or "rS" (Reverse), use parameter knob 1 to set the TRG/GT parameter (trigger/gate mode).**

tS (Trigger One-Shot)

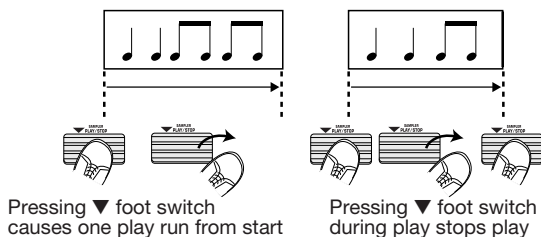

tL (Trigger Loop)

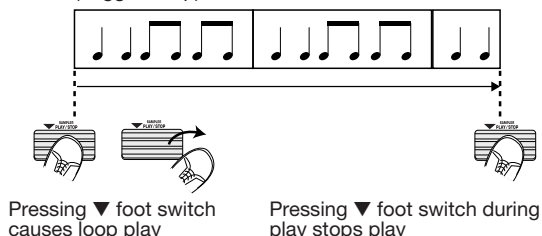

GS (Gate One-Shot)

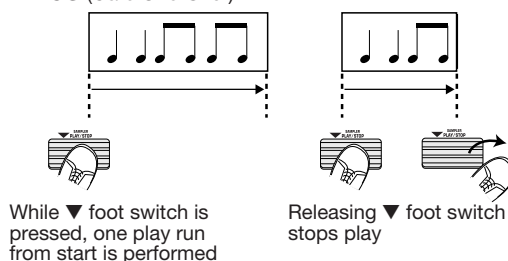

GL (Gate Loop)

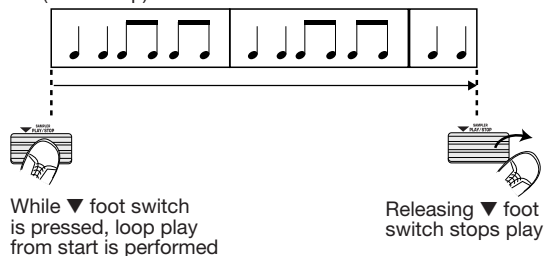

rS (Retrigger One-Shot)

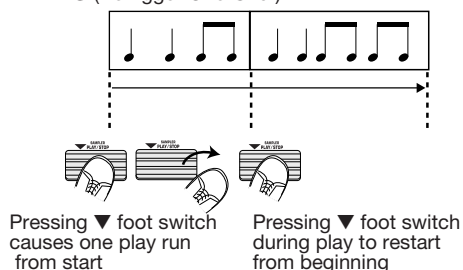

When the STYLE parameter is set to "SC", this parameter has no effect.

- 5 Move to the PEDAL module and assign the expression pedal to the REV module (p. 22).**
- 6 Store the patch and return to the play mode.**

In play mode, when a patch where JAM Play can be used is selected, the REV and PEDAL module LEDs are flashing.

7 Push down the expression pedal fully.

The GFX-707 enters the Jam Play mode and goes into the recording standby condition. The indication "JP" is shown on the BANK/PATCH indicator.

8 While playing your instrument, press the ▲ foot switch when you want to start recording.

As opposed to the regular sampler function, the signal recorded for Jam Play always is processed by the currently selected effects.

9 To stop recording midway, press the ▼ foot switch. Alternatively, after 2 seconds, recording stops automatically.

10 Use the ▼ foot switch or the expression pedal to control play/stop of the recorded phrase.

The function of the ▼ foot switch and expression pedal depends on the STYLE parameter and TRG/GT parameter setting.

When "nM" or "rS" is selected as STYLE parameter, the expression pedal can be used to adjust the level of the playback signal.

To record and play a new phrase, repeat steps **8 - 10**.

11 To terminate the Jam Play mode, push the expression pedal once more fully down or press the EDIT (CANCEL) key.

Also after terminating the Jam Play mode, the most recent recorded phrase is temporarily retained by the unit and can be used again when a patch is selected for which Jam Play is enabled. If Jam Play is enabled for both patches, it is also possible to switch between patches while playing the recorded phrase.

When the regular sampler is used or when the unit is turned off, the phrase is cleared.

Controlling an Effect With the Pedal

The expression pedal of the GFX-707 can be used to control the volume or parameters of the COMP•DIST, MOD, and REV modules in real time.

1 In edit mode, use the MODULE ◀/▶ keys to cause the PEDAL module LED to flash.

When wishing to control a parameter with the expression pedal, the parameter must first be assigned to the pedal in edit mode.

2 Use the parameter knob 1 to select the assign target for the expression pedal. Parameter 1 of the PEDAL module is the ASSIGN parameter.

The following targets can be selected: "VL" (Volume), "dS" (COMP•DIST module), "Md" (MOD module), "rv" (REV module). When a module to which the pedal is assigned is called up, the indication "Pd" appears on the BANK/PATCH indicator.

The parameter that is actually controlled is predetermined for every effect type in the module. This parameter is indicated by a pedal mark in the description on **pages 17 through 20**.

3 Use parameter knob 2 to select the way the parameter changes when the pedal is moved.

Parameter 2 is the MODE parameter that determines the range and direction of the change caused by the expression pedal. Available settings are "UP", "dn" (Down), Hi (High), Lo (Low).

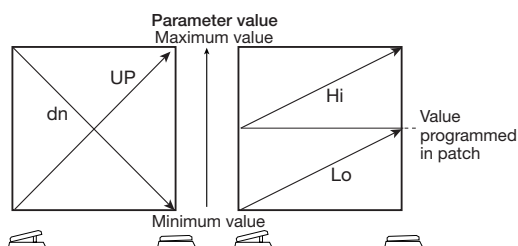

4 Store the patch and return to the play mode.

Verify that the module to which the pedal was assigned is ON.



For information on the volume change when using the expression pedal as a volume pedal, see the explanation of the MINVOL parameter in the PEDAL volume (p. 20).

- 5 While the stored patch is selected, move the expression pedal. The parameter assigned to the pedal in edit mode should change.
- 6 To switch the ON/OFF status of a module assigned to the pedal, push the expression pedal fully down.

In play mode, pushing the expression pedal fully down switches the ON/OFF status of a module.



- There is one exception to the above behavior. If a patch is selected for which Jam Play (p. 21) is active, pushing the expression pedal fully down will activate Jam Play mode and cause the GFX-707 to go into the recording standby condition.
- When using the expression pedal as a volume pedal, pushing the pedal fully down has no effect other than raising the volume.

All Initialize/Factory Recall

The All Initialize/Factory Recall function is a special function that lets you reset the GFX-707 to the condition in which it was originally shipped. When All Initialize is performed, all patches in the USER group and all other settings of the unit are returned to the default condition. Factory Recall can be used to reset specific patches in the USER group to the default settings.

- 1 Turn power to the GFX-707 on while keeping the STORE key depressed.

The indication "ALINIT" flashes on the display.

- To perform All Initialize → Continue with step 2
- To perform Factory Recall → Use the ▼/▲ foot switches and TYPE (BANK) ▼/▲ keys to select the patch (from the USER group) that you want to return to the factory default condition.

- 2 Press the STORE key once more.

All Initialize or Factory Recall is carried out. If All Initialize was carried out, the unit automatically returns to the play mode.

Important: When All Initialize is executed, the contents of all patches stored by the user will be overwritten (erased). When wishing to cancel All Initialize/Factory Recall, press the EDIT (CANCEL) key before step 2.

Adjusting the Expression Pedal

The expression pedal of the GFX-707 uses a highly reliable optical sensor mechanism. The pedal is adjusted for optimum operation at the factory, but sometimes, readjustment may be necessary. If on/off switching is not performed when the pedal is fully pushed down, or if on/off switching occurs even if the pedal is only lightly pushed, adjust the pedal as follows.

- 1 Turn power to the GFX-707 on while keeping the SAMPLER key depressed.

The indication "MIN" flashes on the display.

- 2 With the expression pedal fully raised, press the STORE key.

The display indication changes to "MAX".

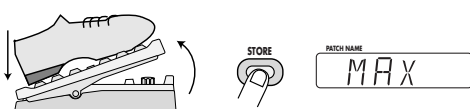

- 3 Push the expression pedal fully down and then lift your foot off the pedal (the pedal goes back a little). Press the STORE key at this point.

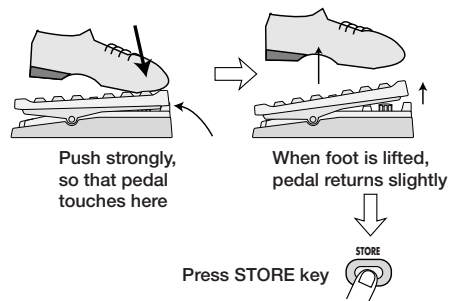

The adjustment is completed, and the unit returns to the play mode.



The point where the STORE key is pressed in step 3 determines the on/off switching point. If you want the pedal to perform on/off switching with a lighter touch, push the key at a somewhat higher position of the pedal.

Troubleshooting

Symptom	Check	Remedy
No sound or very low volume	• Is suitable AC adapter connected, and power switch set to ON?	⇒ Make connections as described in "Getting Connected" and turn power on.
	• Is instrument connected correctly to INPUT jack and playback equipment to OUTPUT jack?	⇒ Make connections as described in "Getting Connected".
	• Is shielded cable defective?	⇒ Try using another cable.
	• Is amplifier turned on? Are level controls for instrument and amplifier set to proper values?	⇒ Turn amplifier on and adjust volume to proper level.
	• Is GFX-707 set to mute condition?	⇒ Cancel the mute condition.
	• Is OUTPUT knob turned down?	⇒ Set OUTPUT knob to proper position.
	• Is expression pedal raised?	⇒ For some patches, the expression pedal controls the volume. Set it to a suitable position.
Sound of CD player or other equipment connected to INPUT jack is not heard (sampling is not carried out)	• Is output level of CD player set to appropriate position?	⇒ Adjust level.
Rhythm pattern is not played	• Is rhythm volume turned down?	⇒ Use PARM 3 knob to adjust the volume.
Expression pedal on/off switching is not performed properly	• Readjusting the pedal may correct the problem.	⇒ Readjust pedal, as described on page 23.

GFX-707 Specifications

Effect Programs	48 types (43 effects + 4 amp simulator settings + ZNR)	Output	Combined line/headphone output Standard stereo phone jack (maximum output level = +3 dBm with output load impedance of 10 kilohms or higher)
Effect Modules	4 modules + amp simulator + ZNR	Display	6-position alphanumeric LED display 2-position 7-segment LED display
Sampler Function	Maximum recording time: 6 seconds Playback speed control <MOD and REV modules are temporarily turned off when sampler function is used>	Power Supply	AC adapter (available separately) 9 V DC, center minus, 300 mA (ZOOM AD-0006) Batteries: IEC R6 (size AA) x 4 Continuous operation: approx. 14 hours (with alkaline batteries)
Patch Memory	USER: 6 banks x 5 = 30 (rewritable, with store) PRESET: 6 banks x 5 = 30 Total 60 patches	External Dimensions	235 mm (W) x 189 mm (D) x 54 mm (H)
Sampling Frequency	31.25 kHz	Weight	740 g (without batteries)
A/D Conversion	20-bit, 64-times oversampling		
D/A Conversion	20-bit, 128-times oversampling		
DSP	ZOOM original ZFx-2		
Input	Guitar input: standard mono phone jack (Nominal input level -20 dBm, input impedance 470 kilohms) Also serves as AUX IN for standard stereo phone jack	* 0 dBm = 0.775 Vrms * Design and specifications subject to change without notice.	

ZOOM®
CATCH US IF YOU CAN

ZOOM CORPORATION

NOAH Bldg., 2-10-2, Miyanishi-cho, Fuchu-shi, Tokyo 183-0022, Japan
PHONE: 042-369-7116 FAX: 042-369-7115